

2016

Students' Perception of the Flipped Classroom in Graphical Communications

Lulu Sun

Embry-Riddle Aeronautical University, sunl@erau.edu

Follow this and additional works at: <https://commons.erau.edu/publication>



Part of the [Education Commons](#), and the [Engineering Education Commons](#)

Scholarly Commons Citation

Sun, L. (2016). Students' Perception of the Flipped Classroom in Graphical Communications. , (). Retrieved from <https://commons.erau.edu/publication/490>

Sun, L. (2016). Students' perception of the flipped classroom in graphical communications, ASEE Engineering Design Graphics Division - 71st Midyear Conference, Nashua, NH, October 16-18, 2016. This Conference Proceeding is brought to you for free and open access by Scholarly Commons. It has been accepted for inclusion in Publications by an authorized administrator of Scholarly Commons. For more information, please contact commons@erau.edu.

Students' Perception of the Flipped Classroom in Graphical Communications

Lulu Sun

Department of Engineering Fundamentals

Embry-Riddle Aeronautical University

Abstract

The flipped classroom requires students to study concepts before the class, apply what they learn in the classroom, and work with other students, which then makes it possible to get immediate feedback from the instructor. However, the student's perception of the flipped classroom is not widely investigated in the area of engineering graphics. This paper presents a study of the flipped classroom in a Graphical Communications course. Students are required to study course material online before the face-to-face classroom experience. The online course study includes multimedia materials and an online quiz that they are required to take. The results of anonymous student surveys show that flipped classroom is effective only when it is designed in an appropriate way.

Introduction

Both the American Society for Engineering Education (Jamieson & Lohmann, 2009) and the National Academy of Engineers (2005) have called for education reform that focuses on developing engineering graduates that are self-learners and problem-solvers. The idea of the flipped classroom is to train students to be self-learners, to study concepts before the class, and to dedicate more classroom time to learner-centered activities so that immediate feedback and assistance can be provided to the students (Vygotsky, 1978; Foot & Howe, 1998; Lage & Platt, 2000). A flipped class is different from an online class because it still involves face-to-face class time with the instructor and it emphasizes interactive group learning activities during the class time (Branoff & Kelly, 2009; Bishop & Verleger, 2013). Especially in today's world, it offers students computer-based individual instruction and requires them to finish closed-ended quizzes and exercises online (Bishop, 2013). Instructors will clarify and reinforce the misconceptions in the class based on the online assessment that is collected (Lage, Platt & Treglia, 2000; Bishop & Verleger, 2013). A pilot study of flipped classroom was conducted in a Graphical Communications course at a private institution in the southeast in fall 2015. The objective of the study was to incorporate the flipped classroom to part of the course to examine the effectiveness on teaching and student learning. After the success of the pilot study, the course was completely flipped in spring 2016. This paper presents students' perception of flipped classroom in the Graphical Communications course in two semesters.

Course Structure

The Graphical Communications course was designed to familiarize the students with the basic principles of drafting and engineering drawing, to improve three dimensional (3D) visualization skills, and to teach the fundamentals of a computer aided design. The class met twice a week in the laboratory during this three-credit-hour semester-long course with each class lasting one hour and forty-five minutes. Online materials and quizzes were available to students about three days before each face-to-face class. The materials were used to explain the concepts and include both audio or video recorded lectures, power point slides, and numerous examples. After each online study, there was a formal assessment, which consisted of five tiered multiple-choice questions. Students were allowed to take the quiz up to two times and the better score was included in their weighted grades. The quiz needed to be completed no later than the midnight before the class so that the instructor could catch common mistakes and clarify the misconceptions in the class. Classes were always interactive and focused on questions and answers, the team exercises, hands-on activities, and homework completion. A screenshot of the online study of lines and scales is shown in Figure 1, and an online quiz is shown in Figure 2 respectively.

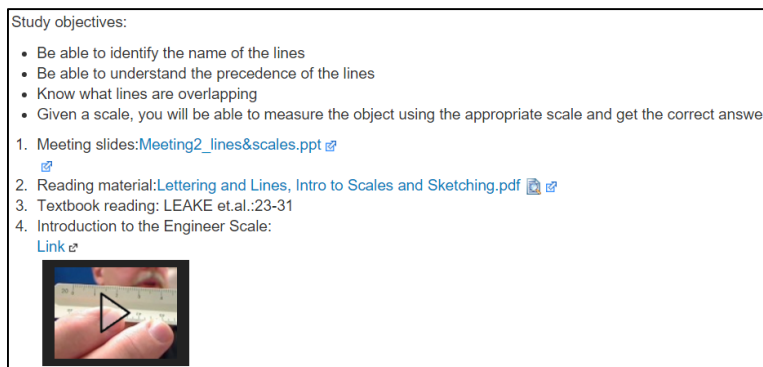

Figure 1. Online study of lines and scales

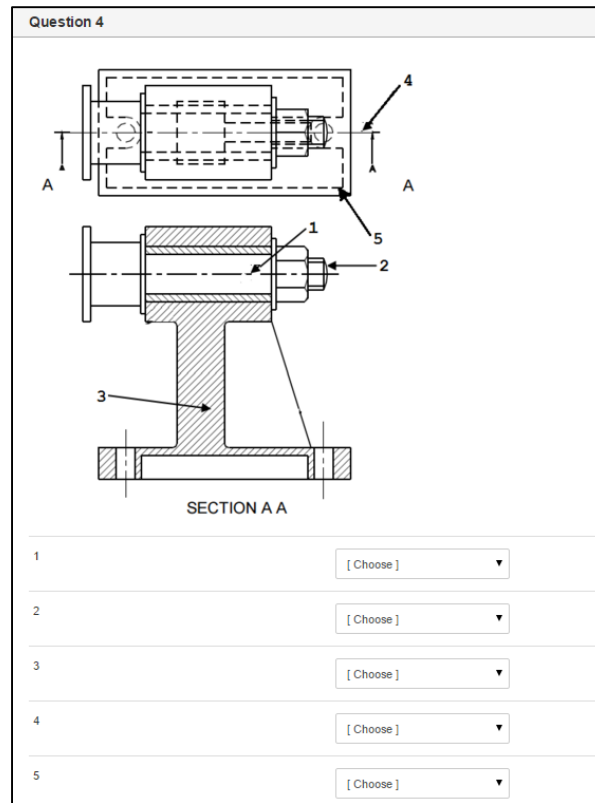

Figure 2. Online quiz of lines

Results

To understand students' perceptions of the flipped classroom, an anonymous midterm survey was administered by Center for Teaching and Learning Excellence (CTLE) at the institution in each semester. 82% students (44 out of 54) in fall 2015 and 78% students (46 out of 59) in spring 2016 were completed the survey. Figure 3 indicates that about 70% students are in favor of the flipped class format in two semesters. Over 64% students spent one hour or more on each online study as shown in Figure 4. Figure 5 illustrates that about 60% students would like to continue in the flipped classroom format for the remainder of the semester. *Do they prefer the flipped format if they had to take the course again?* The students' responses were split as shown in Figure 6.

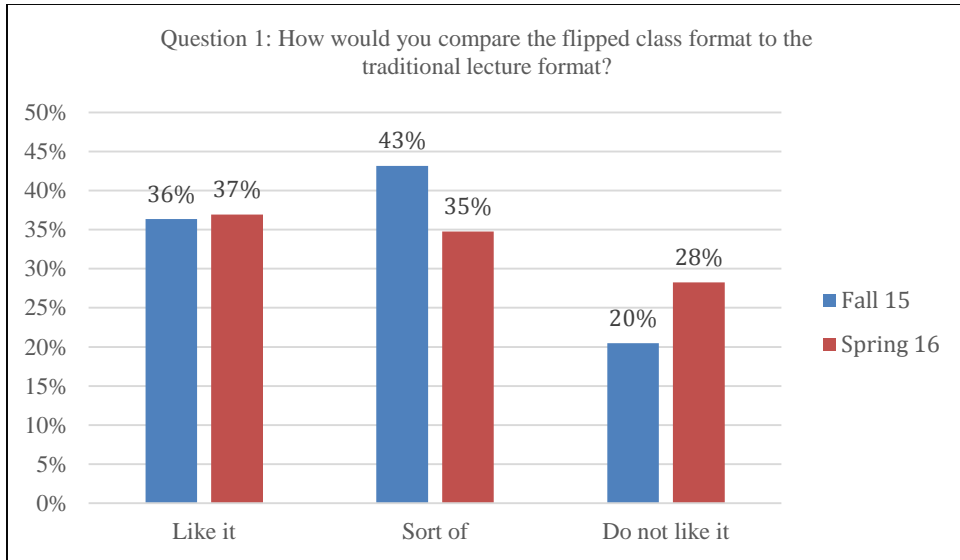

Figure 3. Survey question 1 responses

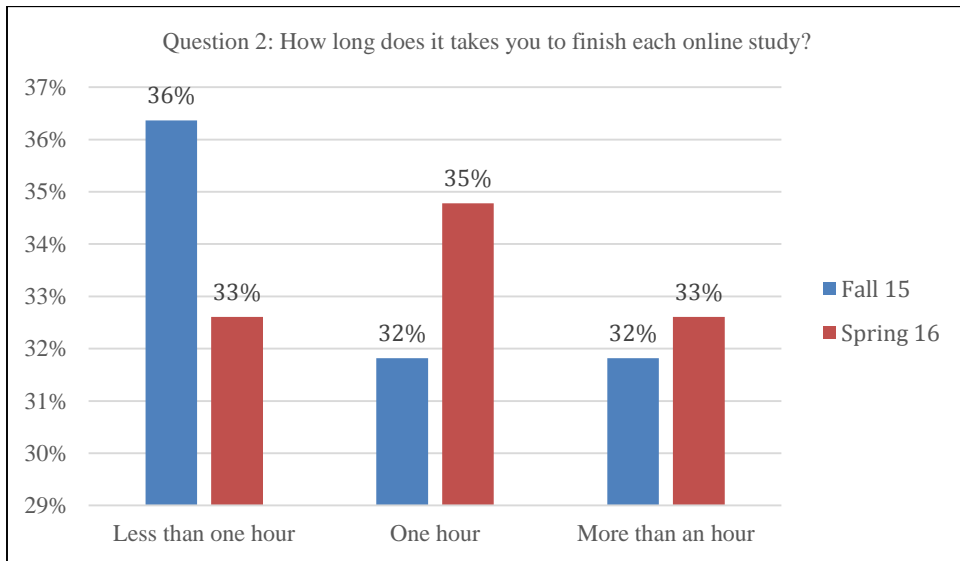

Figure 4. Survey question 2 responses

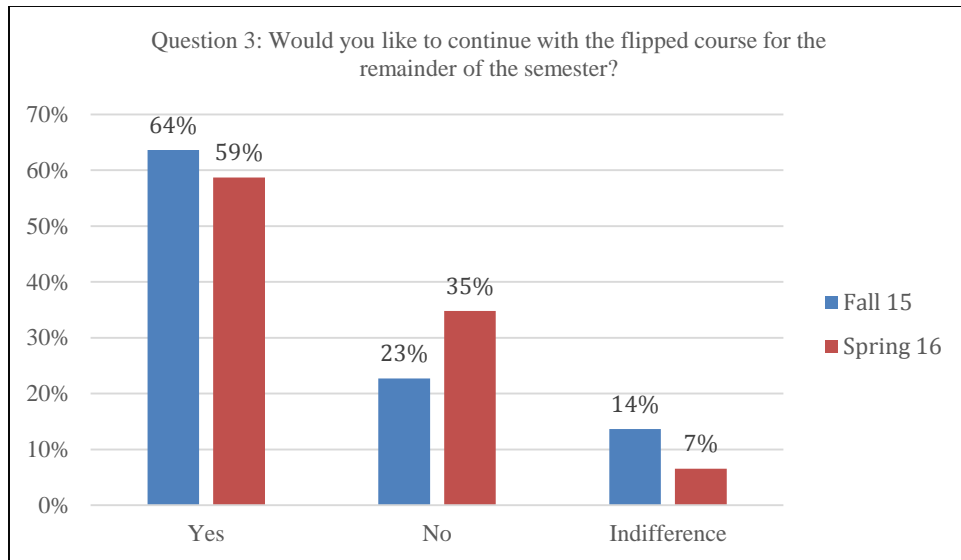

Figure 5. Survey question 3 responses

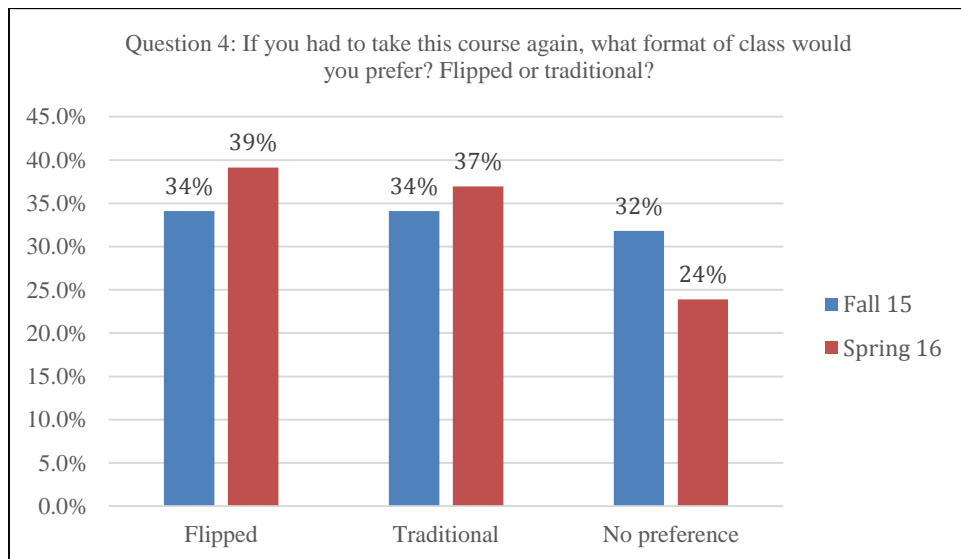

Figure 6. Survey question 4 responses

The following are comments from students regarding the flipped classroom approach (not corrected for grammatical errors or spelling mistakes).

- *I enjoy having time to do homework during class time. (Spring 2016)*
- *edpuzzle videos so we can answer questions during ONE video rather then jumping around to multiple. (Spring 2016)*
- *Provide answers after the second attempt of the quiz online so we can study the right answers. (Spring 2016)*

- *Make a video for the more difficult exercises from the textbook that is included for the homework. (Spring 2016)*
- *The whole "flipped" idea, where we teach ourselves outside of class, doesn't work well. It's a good theory and worked with drawing and sketching, but I don't think it works with CATIA, an extremely complicated program. (Spring 2016)*
- *Sometimes the answers come up and sometimes it will just say the incorrect answer.*
- *videos and then quizing at the end. (Spring 2016)*
- *Try to not post many videos, 7 or 8 are Ok but no more. (Spring 2016)*
- *The online resources like powerpoints and whatever help because we usually look over it at home before doing it in class, so we kinda get a preview and that helps. (Fall 2015)*
- *By going over examples and then being able to start the homework in class. We can watch her do examples and do them on our own as well. The study material being posted online was very helpful. (Fall 2015)*
- *The attention to detail; online study guides/power point presentations; the in class examples. The two chances to take the online quizzes at the beginning of the course was very helpful. (Fall 2015)*
- *This course is partly depending on practice and out of class learning, which has allowed me to develop autodidactic skills. However, Professor Sun is very proficient in explaining things that we might find difficult to understand. For example, lettering was something that we had to learn ourselves, but it just required practice. On the other hand, she made us learn line types but helped us understand the difficult subjects concerning their use. (Fall 2015)*

There are more positive comments in fall 2015 when partial topics were flipped. From students' comments we can see that students are in favor of the flipped classroom when the freehand sketching was covered. Students do not like the flipped concept when CATIA was covered because of the complicated program and heavy workload. They prefer more interactive online videos.

Students' positive feedback about flipped classroom also reflected on their improved academic performance. Since the non-flipped class in spring 2015, pilot study of the flipped classroom in fall 2015, and a completely flipped classroom in spring 2016 were all taught by the same instructor and covered the same topics, it provided an opportunity to evaluate the effectiveness of the flipped classroom on student learning. The identical quizzes and exams were given in these three semesters and were graded by the same instructor using the same rubric. The data were collected and compared in Figure 7. The two quizzes were given before the exam 1, which was given after first month study. Since it was still the early semester, it was hard to tell the effectiveness of the flipped classroom from the quiz scores. As more difficult topics were covered after the quizzes, the average exam

grade in the flipped classes became higher than the grade in the non-flipped class, which probably due to substantially more practice online and in the class time. Flipped class showed improved student's academic performance even though they did not know the comparison results. There were two exams given after exam 1. Due to the problem change and the teaching pedagogy change, these exam scores were not included in this study. More data will be collected to support this conclusion.

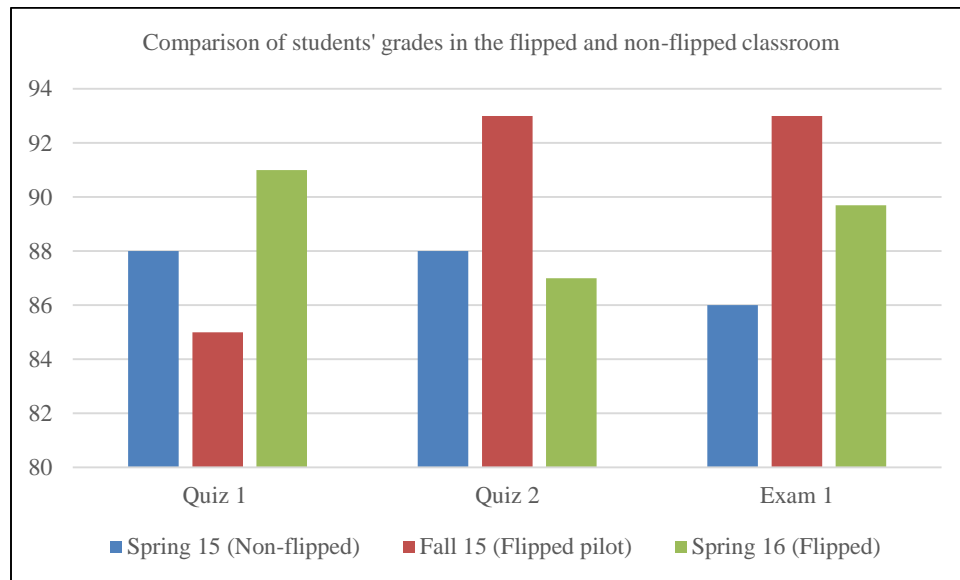

Figure 7. Comparison of students' grades in the flipped and non-flipped classroom

Conclusions

A pilot study of the flipped classroom in the Graphical Communications course was conducted in fall 2015 and a fully flipped classroom was completed in spring 2016. A midterm survey was administered to understand student's perception in each semester. From anonymous student surveys we found that because of the flipped classroom, students like the pace and the examples and the time to do work in class. Students like to watching interactive videos than reading the textbook. Students' positive feedback about the flipped classroom also reflected on their improved academic performance. In summary, the flipped classroom approach is effective only if it is used appropriately. It depends on interactive online classroom design, active learning in the face to face classroom, and continuous improvement based on student input.

Acknowledgment

This work was sponsored by Center for Teaching and Learning Excellence (CTLE) at Embry-Riddle Aeronautical University.

References

- Bishop, J.L. (2013) *A Controlled Study of the Flipped Classroom with Numerical Methods for Engineers*. (Doctoral dissertation), Utah State University, Logan, UT, Retrieved from <http://digitalcommons.usu.edu/cgi/viewcontent.cgi?article=3011&context=etd>
- Bishop, J.L. and Verleger, M.A. (2013) *The Flipped Classroom: A Survey of the Research*, 120th ASEE Annual Conference and Exposition, Jun 23-27.
- Branoff, T.J. and Kelly, W. F. (2009). *Blended Instruction in an Introductory Engineering Graphics Course*. In the proceedings of the 64th Engineering Graphics Division of the American Society for Engineering Education Midyear Meeting, Erie, Pennsylvania.
- Foot, H. and Howe, C. (1998). *The psychoeducational basis of peer-assisted learning*. In K.J. Topping and S.W. Ehly, editors, *Peer-Assisted Learning*, pages 27–43. Lawrence Erlbaum Associates.
- Jamieson, L.H. and Lohmann, J.R. (2009), *Creating a Culture for Scholarly and Systematic Innovation in Engineering Education: Ensuring U.S. Engineering has the Right People with the Right Talent for a Global Society*, American Society for Engineering Education: Washington, D.C.
- Lage, M.J. and Platt, G. J. (2000) *The Internet and the Inverted Classroom*, *Journal of Economic Education*, 31, 11.
- Lage, M.J. Platt, G.J. and Treglia, M. *Inverting the classroom: A gateway to creating an inclusive learning environment*. *The Journal of Economic Education*, 31(1):30–43, 2000.
- NAE (2005), *Educating the Engineer of 2020: Adapting Engineering Education to the New Century*. National Academic of Engineering: Washington, D. C.
- Vygotsky, L.S. (1978) *Mind and society: The development of higher mental processes*. Cambridge, MA: Harvard University Press,